

**GAGEMAKER**

---

***BX-1000/BXG-1000  
Groove Diameter and  
Width Gages***

***OPERATION MANUAL***

---

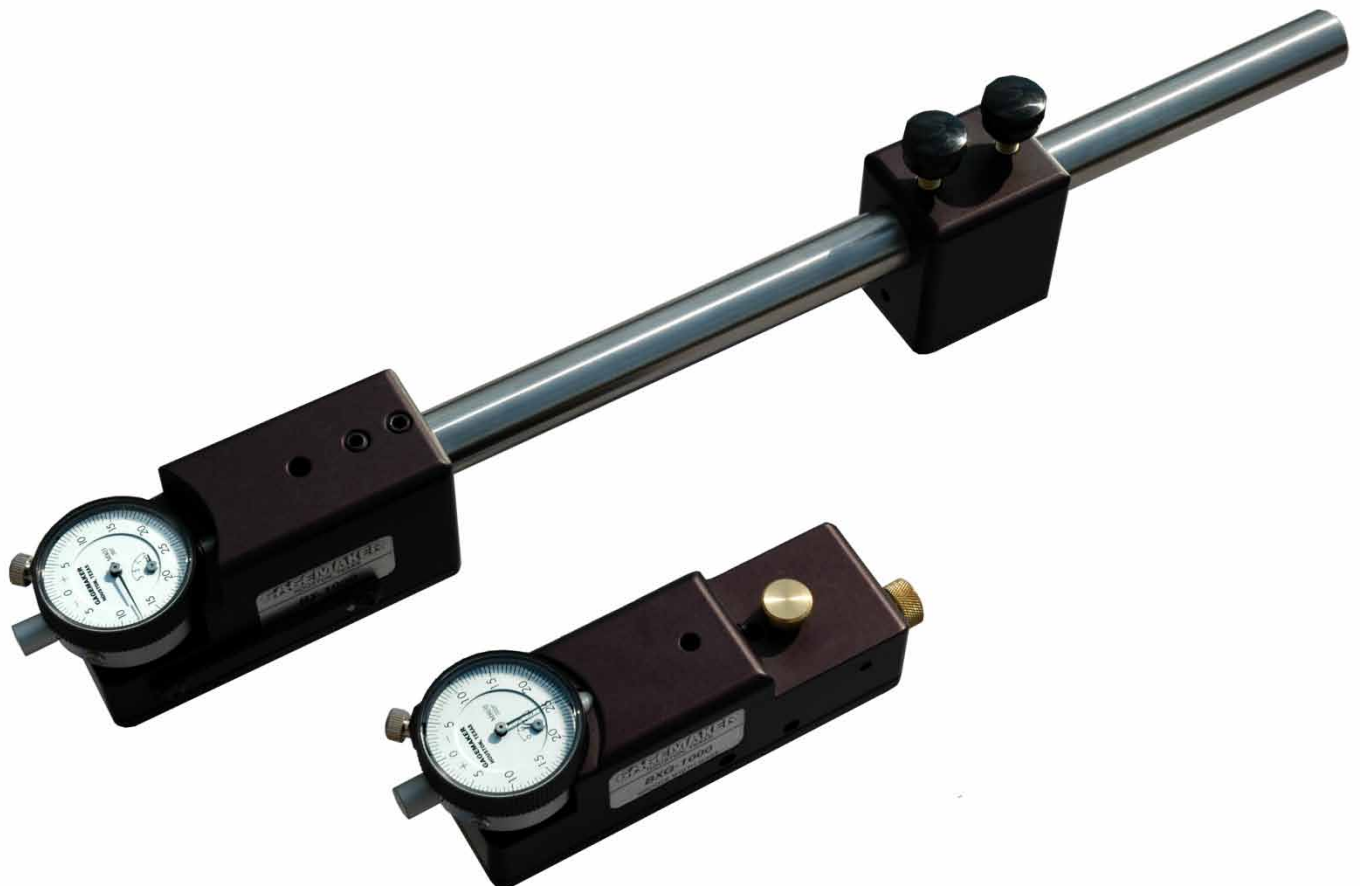

©2012 Gagemaker, LP  
Rev Nov. 28, 2012  
OMBX100011-01

## **Contents**

### **Introduction**

Technical Support	7
Product Information and Updates	7

### **System Components**

BX-1000 Gage Component List	8
BXG-1000 Gage Component List	9

### **BX-1000 Setup Procedures**

Setting Up the BX-1000 Gage	10
Zeroing the BX-1000 Gage Using the MIC TRAC	14
Changing from Internal to External Measurement direction	18

### **BX-1000 Operating Procedures**

Inspecting Parts with the BX-1000 Gage	19
--	----

### **BXG-1000 Setup Procedures**

Setting Up the BXG-1000 Gage	21
Zeroing the BXG-1000 Gage Using Gage Blocks	23
Zeroing the BXG-1000 Gage Using the MIC TRAC	25

### **BXG-1000 Operating Procedures**

Inspecting Parts with the BXG-1000 Gage	29
---	----

### **Groove Inspection Tolerances**

6R & 6RX Groove Tolerances	31
6BX Groove Tolerances	31

### **Setting Dimensions**

MIC Over Ball Setting Dimensions	32
Origin of MIC TRAC Setting Dimensions	33
MIC TRAC Setting Dimensions	34

### **Care and Maintenance**

Maintenance Tips	35
Warranty Information	35



Congratulations! Your decision to purchase a Gagemaker product above all others on the market demonstrates your confidence in our quality and workmanship.

To ensure the high performance and operation of our product, we urge you to use the included reference materials. They contain important information for proper installation, setup, and use of the equipment. In addition, we recommend that you follow the care and maintenance tips in this manual to keep the equipment working in top condition.

If your questions are not addressed in our reference materials, contact your local representative or a customer service representative at 713-472-7360 or [info@gagemaker.com](mailto:info@gagemaker.com).



## ***Introduction***

The BX-1000 and BXG-1000 gages measure face groove diameters and widths. These gages adjust to cover all sizes of R, RX, and BX ring grooves. The standard BX-1000 gage measures groove diameters from 2.6" – 13". Optional rails extend the range of diameters from 13" – 36". The BXG-1000 inspects groove widths from .34" – 1.5".

The BX-1000 can be used to measure straight or tapered groove diameters, shallow bores, and hole locations. The gage ships standard with .188" diameter contact points. The BXG-1000 measures widths of straight or tapered grooves and includes .072" diameter contact points.

The BX and BXG gages use precision contact points for accurate measurement of the ring groove diameter and width at the critical sealing point of the face groove.

Before inspecting parts, the BX and BXG gages require presetting to a nominal predetermined dimension. The Groove Inspection Tolerances and Setting Dimension tables in this manual determine the gage's setting dimensions and gauging tolerances. The BX-1000 gages can be preset using micrometers, gage blocks, or the MIC TRAC MT-3000 measurement center.

To inspect parts, place the contact points in the groove of the part and the gage is positioned by sweeping to obtain an indicator reading. Gage indicators show actual deviation from the preset master dimension. Taking measurements in several different locations along the groove will provide an average groove diameter or groove width. In addition, we recommend that the gage be zeroed periodically during use to maintain accurate readings.

## **Technical Support**

Phone: 713-472-7360

Hours: Monday – Friday 8AM – 5PM (CST)

## **Product Information and Updates**

Visit our web site: [www.gagemaker.com](http://www.gagemaker.com)

### System Components

Take some time to become familiar with all the parts that make up the BX-1000 gages by reviewing the labeled diagram below. The part names are important for understanding the operating instructions.

#### BX-1000 Model Gauge

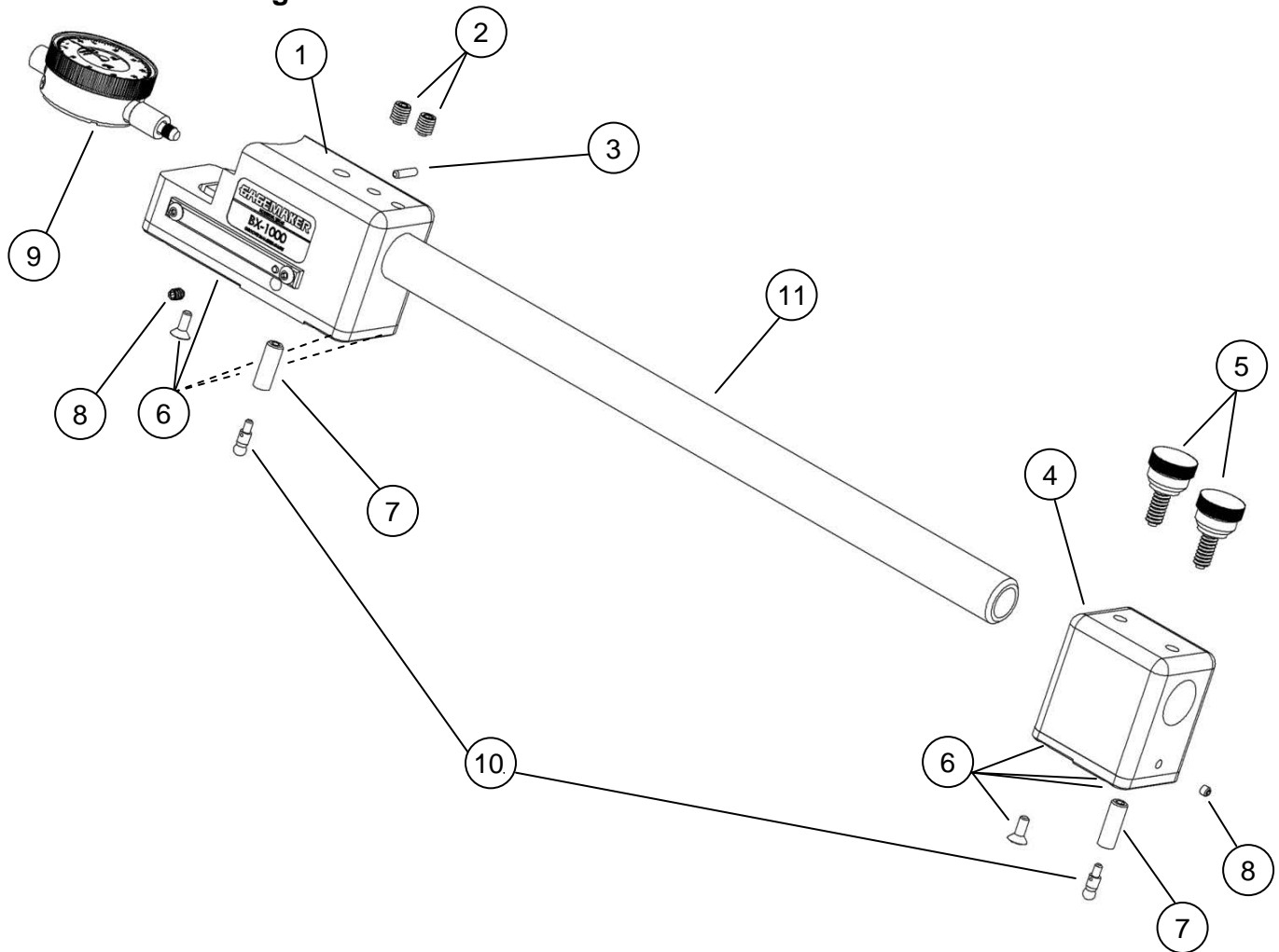

#### Component List

Item	Description	Model	Qty	Item	Description	Model	Qty
1	Upper block assembly with wear pad	BX-1000-1A	1	7	Contact point adjustment screw (1/4-28 x 3/4")	BX-1000-7A	2
2	Extension rod lock screw	BX-1000-2A	2	8	Contact point lock screw	BX-1000-8A	2
3	Indicator set screw	BX-1000-3A	1	9	Indicator	803 or 513SGA	1
4	Lower block assembly with wear pad	BX-1000-4A	1	10	Contact point	T188	2
5	Lock knob	BX-1000-5A	2	11	Extension rod	BX-R13	1
6	6-32 X 3/8" Flat head wear pad screws	BX-1000-6A	8				



**BXG-1000 Model Gage**

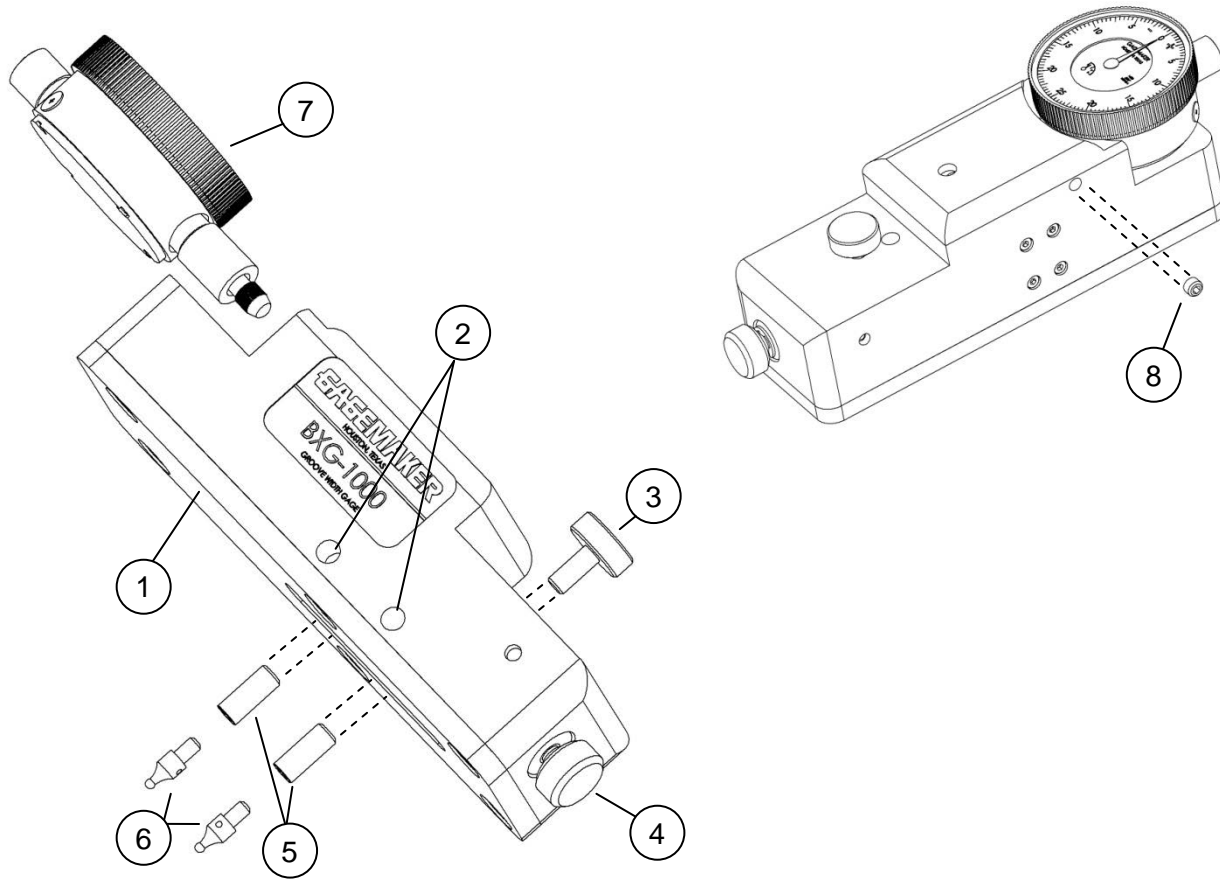

**Component List**

Item	Description	Model	Qty
1	Wear Pad	BXG-1000-1A	1
2	Lock screw (8-32 x 1/8", brass tipped)	BXG-1000-2A	2
3	Rear contact point lock knob	BXG-1000-3A	1
4	Contact point adjustment knob	BXG-1000-4A	1
5	Contact point adjustment screw (10-32 X 1/2")	BXG-1000-5A	2
6	Contact point	T072	2
7	Indicator	803 or 513SGA	1
8	Indicator lock screw (8-32 x 1/8")	BX-1000-3A	1

## *Setup Procedures*

### **Setting Up the BX-1000 Gage**

#### **Materials Needed:**

- BX-1000 gage
- Gage blocks

1. Inspect the contact points to ensure that they are tight.
2. Loosen the lower block locking knobs and slide the lower block off the extension rod.
3. Remove the lower block locking knob so the contact point can be adjusted.

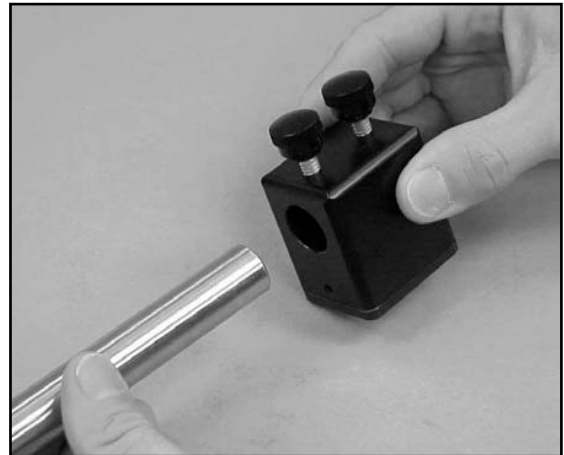

**Setting Up the BX-1000 Gage (continued)**

4. Using a 5/64" hex wrench, loosen the contact point set screw in the lower block.



5. Place a 1/8" hex wrench down the access hole in the top of the lower block.
6. Using a .188" gage block, turn the hex wrench to adjust the set screw so the distance from the wear pad to the bottom of the contact point is .188".

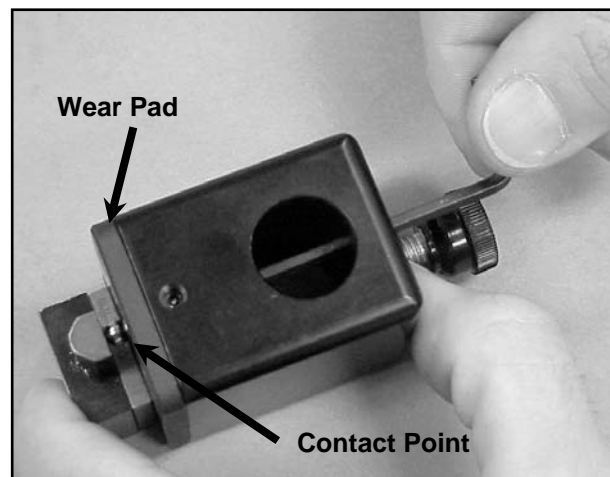

7. Using the 5/64" hex wrench, tighten the contact point in the lower block.



**Setting Up the BX-1000 Gage (continued)**

8. Using a 5/64" hex wrench, loosen the contact point in the upper block.



9. Place a 1/8" hex wrench down the access hole in the top of the upper block.

10. Using a .188" gage block, turn the hex wrench to adjust the set screw so the distance from the wear pad to the bottom of the contact point is .188".



11. Using the 5/64" hex wrench, tighten the contact point in the upper block.



**Setting Up the BX-1000 Gage (continued)**

12. Replace the locking knob in the lower block.
13. Place the lower block on the extension rod and tighten the locking knob to secure.

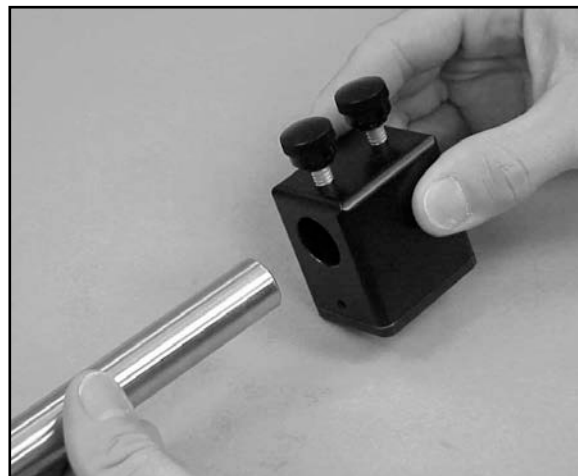

## Zeroing the BX-1000 Gage Using the MIC TRAC

### Materials Needed:

- BX-1000 gage
- MIC TRAC Setting Dimensions Table
- MIC TRAC MT-3000



To ensure consistent and accurate readings, the BX-1000 gage should be zeroed on the MIC TRAC once during each shift, at a minimum.

1. Mount the TF-BX setting blocks on the MIC TRAC.
1. Turn the coarse adjust knob on the MIC TRAC counterclockwise to bring the setting blocks together.
2. Apply slight pressure to hold the faces of the anvils together. Press the  key and the display will read 0.00000.

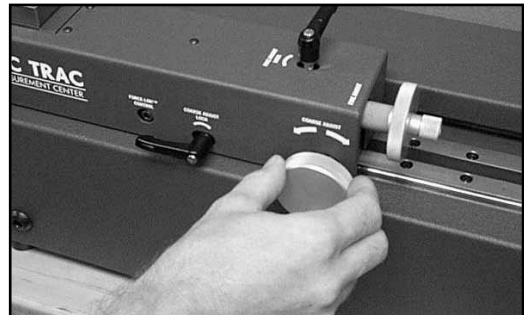

### Zeroing the BX-1000 Gage Using the MIC TRAC (continued)

3. Locate the dimension for the type of groove you are measuring in the MIC TRAC Setting Dimensions table in this manual.
4. Turn the coarse adjust knob on the MT-3000 to display a measurement that is close to the desired setting dimension.
5. Secure the coarse adjust lock.
6. Turn the fine adjust knob until the CPU displays the exact setting dimension.
7. Secure the fine adjust lock.



8. Loosen the lower block locking knobs and slide the lower block to a position that allows the BX-1000 gage to set on the top surfaces of the setting blocks.



9. Place the BX-1000 gage on the setting blocks, positioning the contact points between the setting blocks.



**Zeroing the BX-1000 Gage Using the MIC TRAC (continued)**

10. Rotate the lower block so that the wear pads lay flat on the setting blocks.
11. Adjust the lower block so the contact points touch the setting blocks and the indicator has approximately 0.010" to 0.020" of preload.



12. Tighten the lower block locking knob to secure.



13. While maintaining pressure toward the right setting block, sweep the upper block back and forth to locate the smallest indicator reading.





## Zeroing the BX-1000 Gage Using the MIC TRAC (continued)

14. Turn the indicator dial on the BX-1000 gage to align the needle with zero.



15. Tighten the indicator clamp.

**Note:** Note the position of the small revolution counter on the indicator before removing the gage. Place a piece of masking tape on the side of the gage and record the dial setting of the small revolution counter to eliminate incorrect indicator readings.

16. Set a frequency for verifying the zero setting of all gages. As a minimum, the BX-1000 gage should be zeroed on the MIC TRAC once during each shift to ensure accurate readings.



## Changing from Internal to External Measurement Direction

1. Remove the two screws holding the spring-pin cover plate.



2. Turn the cover plate around 180 degrees.



3. Replace the two cover plate hold down screws.



## *Operating Procedures*

### **Inspecting Parts with the BX-1000 Gage**

#### **Materials Needed:**

- BX-1000 gage
- Part
- Inspection report

4. After zeroing the BX-1000 gage, position the gage on the flange face and into the ring groove of the part.



5. Properly position the contact points in the groove, as shown to the right.



## Inspecting Parts with the BX-1000 Gage (continued)

6. While maintaining pressure toward the lower block and flange face, sweep the gage back and forth, using the lower block as a pivot, to locate the largest indicator reading.

**Note:** Be sure that the small revolution counter on the indicator is pointing to the same number as when the gage was zeroed. Refer to the number previously recorded on the side of the gage.

7. Repeat the process in several locations around the groove to get an average groove diameter.
8. Locate the groove diameter in the 6B & 6BX Groove Inspection Tolerances table in this manual to determine the groove width tolerance.
9. Record the information on an inspection report.
10. Inspect the part with the BXG-1000 to ensure the proper groove width.
11. Use the first part you inspected as a control piece to verify repeatability. Mark the part at a location where it was inspected and record the deviation from zero.
12. During the inspection process, periodically place the BX-1000 on the control piece to verify the gage's accuracy.

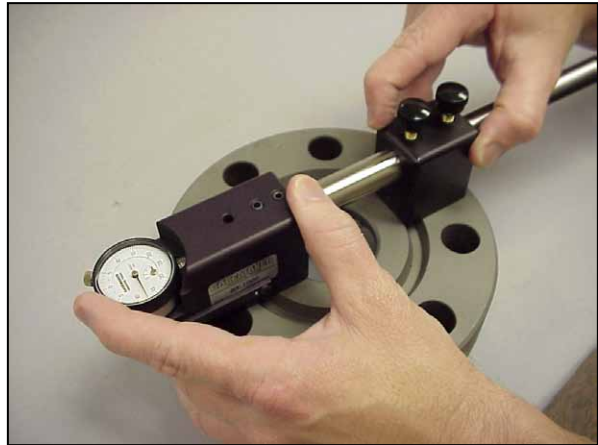

## Setting Up the BXG-1000 Gage

### Materials Needed:

- BXG-1000 gage
- Gage block

1. Inspect the contact points to ensure that they are tight.
2. Loosen the rear contact point lock knob, located on the top of the gage.

3. Turn the contact point adjustment knob, located on the rear of the gage, to adjust the point location until the rear lock screw is aligned with the access hole in the side of the gage body.

**Note:** Aligning the lock screw allows you to place a hex wrench in the access hole and loosen the lock screw.

4. Using the 5/64" hex wrench, loosen the front and rear lock screws.

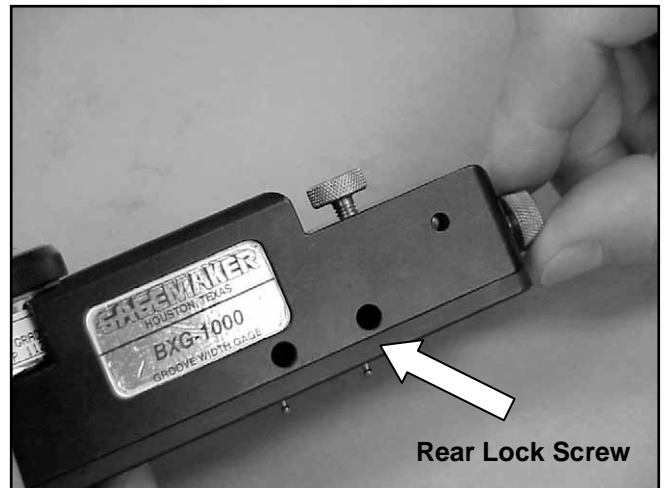
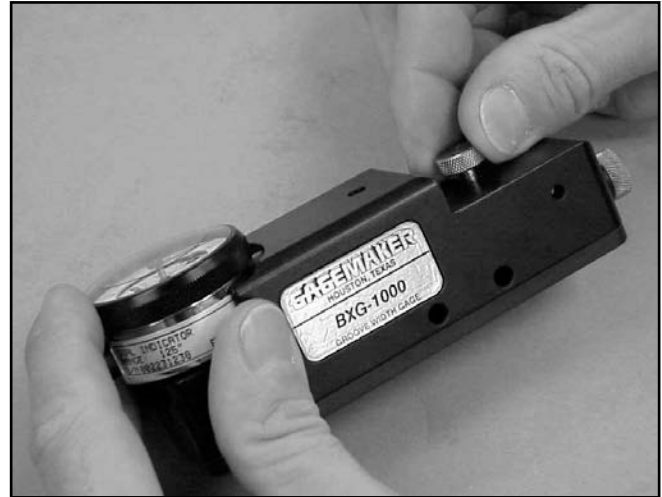

## Setting Up the BXG-1000 Gage (continued)

5. Using a 3/32" hex wrench and proper gage blocks, adjust the height of the contact points as follows:
  - **For setting with the MIC TRAC and TF-BX blocks** – adjustment is approximately  $\frac{1}{2}$  the groove depth.
  - **For setting with a micrometer or gage blocks:** adjustment is .157" from the face of the gage.
  
6. Tighten the front and rear lock screws.

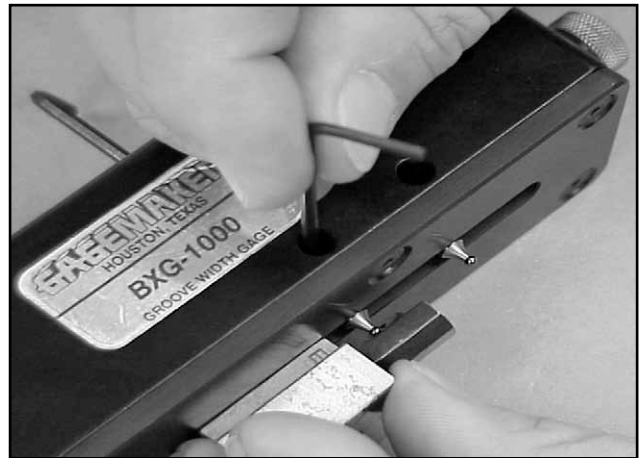
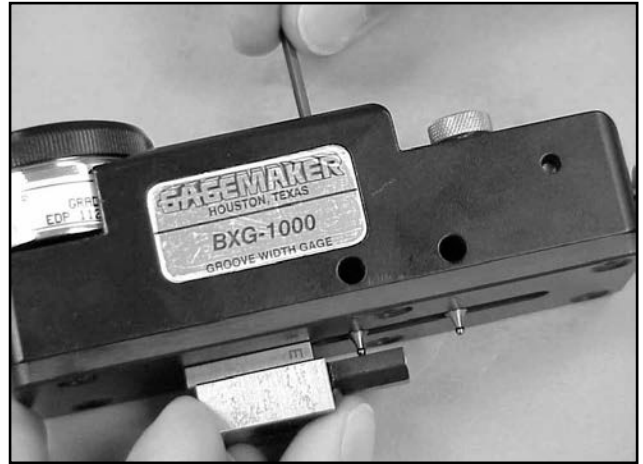

## Zeroing the BXG-1000 Gage Using Gage Blocks

### Materials Needed:

- BXG-1000 gage
- Gage blocks
- MIC Over Ball Setting Dimensions Table



To ensure consistent and accurate readings, the BXG-1000 gage should be zeroed on gage blocks once during each shift, at a minimum.

1. Locate the dimension for the type of groove you are measuring in the MIC Over Ball Setting Dimensions table in this manual.
2. Stack the gage blocks to the proper measurement.
3. Turn the rear contact point lock knob, located on the top of the gage, to loosen the contact point holder.
4. Turn the contact point adjustment knob, located at the rear of the gage, to adjust the location of the rear contact point.
5. Continue turning the adjustment knob until the contact points fit between the gage blocks.
6. Lock the rear contact point lock knob.

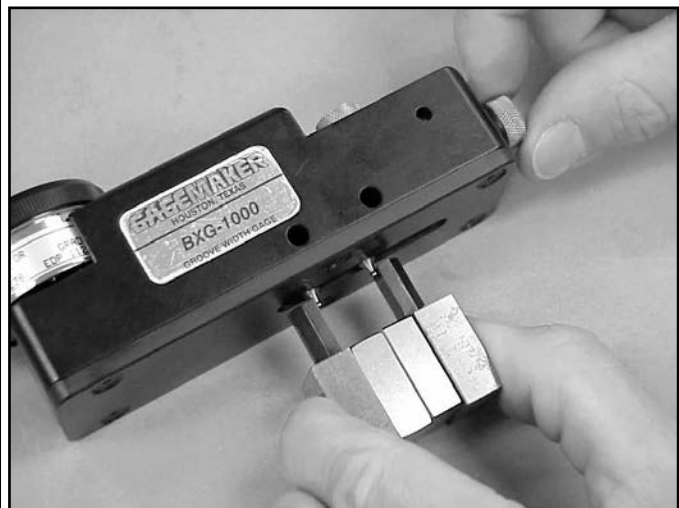
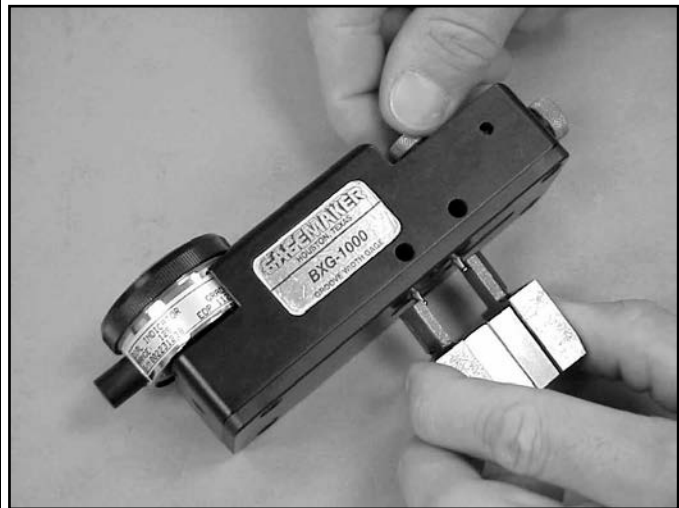

## Zeroing the BXG-1000 Gage Using Gage Blocks (continued)

7. Turn the indicator dial on the BXG-1000 gage to align the needle with zero.



8. Tighten the indicator clamp.

**Note:** Note the position of the small revolution counter on the indicator before removing the gage. Place a piece of masking tape on the side of the gage and record the dial setting of the small revolution counter to eliminate incorrect indicator readings.

9. Set a frequency for verifying the zero setting of all gages. As a minimum, the BXG-1000 gage should be zeroed on gage blocks once during each shift to ensure accurate readings.





## Zeroing the BXG-1000 Gage Using the MIC TRAC

### Materials Needed:

- BXG-1000 gage
- MIC TRAC Setting Dimensions Table
- MIC TRAC MT-3000



To ensure consistent and accurate readings, the BXG-1000 gage should be zeroed on the MIC TRAC once during each shift, at a minimum.

1. Mount the TF-BX setting blocks on the MIC TRAC.
2. Apply slight pressure to hold the faces of the anvils together. Press the  key and the display will read 0.00000.



## Zeroing the BXG-1000 Gage Using the MIC TRAC (continued)

3. Locate the dimension for the type of groove you are measuring in the MIC TRAC Setting Dimensions table in this manual.
4. Turn the coarse adjust knob on the MT-3000 to display a measurement that is close to the desired setting dimension.
5. Secure the coarse adjust lock.
6. Turn the fine adjust knob until the CPU displays the exact setting dimension.
7. Secure the fine adjust lock.
8. If necessary for documentation purposes, press the PRINT pad on the CPU to record the actual setting dimension.



9. Loosen the rear contact point lock knob, located on the top of the gage.



10. Turn the contact point adjustment knob, located at the rear of the gage, to adjust the rear contact point.

11. Continue turning the knob to a position that allows the BXG-1000 gage to set on the top surfaces of the MIC TRAC setting blocks.

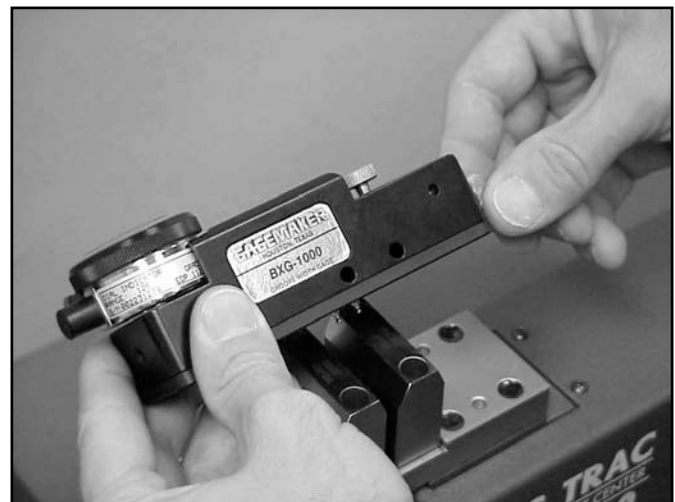

**Zeroing the BXG-1000 Gage Using the MIC TRAC (continued)**

12. Place the BXG-1000 gage on the setting blocks, positioning the contact points between the setting blocks.
13. Adjust the rear contact point until both contact points touch the inside of the MIC TRAC setting blocks.
14. Continue to turn the contact point adjustment knob until the indicator has approximately 0.010" to 0.020" of preload.



15. Tighten the rear contact point lock knob.



16. While maintaining pressure against the rear contact point and setting block, sweep the gage back and forth to locate the smallest indicator reading.

**Note:** Use the rear contact point as a pivot.

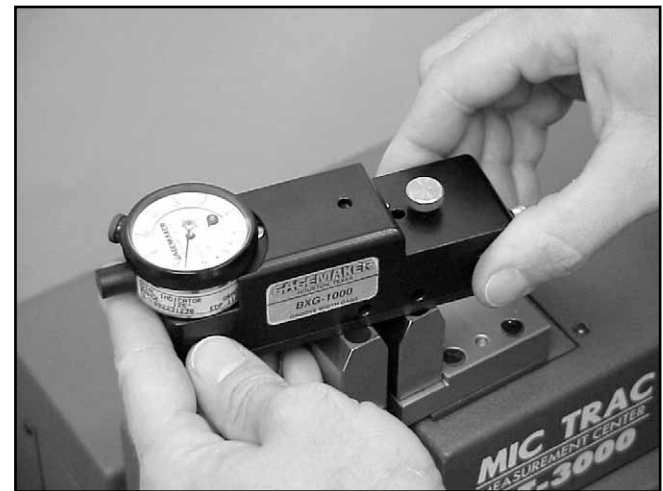

## Zeroing the BXG-1000 Gage Using the MIC TRAC (continued)

17. Turn the indicator dial on the BXG-1000 gage to align the needle with zero.



18. Tighten the indicator clamp.

**Note:** Note the position of the small revolution counter on the indicator before removing the gage. Place a piece of masking tape on the side of the gage and record the dial setting of the small revolution counter to eliminate incorrect indicator readings.

19. Set a frequency for verifying the zero setting of all gages. As a minimum, the BXG-1000 gage should be zeroed on the MIC TRAC once during each shift to ensure accurate readings.



## Operating Procedures

### Inspecting Parts with the BXG-1000 Gage

#### Materials Needed:

- BXG-1000 gage
- Inspection report
- Part

1. After zeroing the BXG-1000 gage, position the gage on the flange face and into the ring groove of the part, as shown.

2. While maintaining pressure against the rear contact point and flange face, sweep the gage back and forth, using the rear contact point as a pivot, to locate the smallest indicator reading.

**Note:** Be sure that the small revolution counter on the indicator is pointing to the same number as when the gage was zeroed. Refer to the number previously recorded on the side of the gage.

3. Repeat the process in several locations around the groove to get an average groove width and record the information on an inspection report.

**Note:** Refer to the 6B & 6BX Groove Inspection Tolerances table in this manual for the allowable groove width variation.

4. Use the first part you inspected as a control piece to verify repeatability. Mark the part at a location where it was inspected and record the deviation from zero.

5. During the inspection process, periodically place the BXG-1000 on the control piece to verify the gage's accuracy.

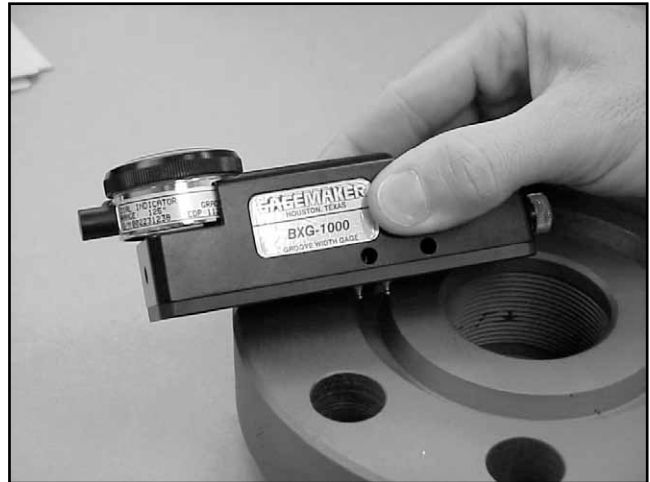



*6R, 6RX & 6BX Groove Inspection Tolerances*

<b>6R Groove Tolerances</b>	
<b>Major Diameter Variation</b> BX-1000 Groove Diameter Gage	<b>Allowable Groove Width Variation</b> BXG-1000 Groove Width Gage
+0.013	+0.008
+0.012	+0.007 to +0.008
+0.011	+0.006 to +0.008
+0.010	+0.005 to +0.008
+0.009	+0.004 to +0.008
+0.008	+0.003 to +0.008
+0.007	+0.002 to +0.008
+0.006	+0.001 to +0.008
+0.005	0.000 to +0.008
+0.004	-0.001 to +0.008
+0.003	-0.002 to +0.008
+0.002	-0.003 to +0.007
+0.001	-0.004 to +0.006
0.000	-0.005 to +0.005
-0.001	-0.006 to +0.004
-0.002	-0.007 to +0.003
-0.003	-0.008 to +0.002
-0.004	-0.008 to +0.001
-0.005	-0.008 to +0.000
-0.006	-0.008 to -0.001
-0.007	-0.008 to -0.002
-0.008	-0.008 to -0.003
-0.009	-0.008 to -0.004
-0.010	-0.008 to -0.005
-0.011	-0.008 to -0.006
-0.012	-0.008 to -0.007
-0.013	-0.008
<b>6BX Groove Tolerances</b>	
<b>Major Diameter Variation</b> BX-1000 Groove Diameter	<b>Allowable Groove Width Variation</b> BXG-1000 Groove Width Gage
+0.004 / -0.000	+0.004 / -0.000

## Setting Dimensions

### MIC Over Ball Setting Dimensions

Use with Micrometers and Gage Blocks  
 Height Over Balls: .188" Diameter = .188"  
 .072" Diameter = .157"

6BX Flange Groove Settings				6B Flange Groove Settings			
Ring Number	Major Diameter Settings	Minor Diameter Settings	Groove Width Settings	Ring Number	Major Diameter Settings	Minor Diameter Settings	Groove Width Settings
BX-150	2.7970	2.0890	0.3411	R-RX20	2.9360	2.4400	0.2351
BX-151	2.9660	2.2260	0.3571	R-RX23	3.6230	2.8770	0.3601
BX-152	3.2990	2.4950	0.3891	R-RX24	4.1230	3.3770	0.3601
BX-153	3.9500	3.0340	0.4451	RX-25	4.2480	3.7520	0.2351
BX-154	4.5890	3.5690	0.4971	R-RX26	4.3730	3.6270	0.3601
BX-155	5.8340	4.6300	0.5891	R-RX27	4.6230	3.8770	0.3601
BX-156	9.4250	7.7750	0.8121	R-RX31	5.2480	4.5020	0.3601
BX-157	11.6780	9.7920	0.9301	R-RX35	5.7480	5.0020	0.3601
BX-158	13.9680	11.8620	1.0401	R-RX37	6.2480	5.5020	0.3601
BX-159	16.9370	14.5710	1.1701	R-RX39	6.7480	6.0020	0.3601
BX-160	15.9670	14.5870	0.6771	R-RX41	7.4980	6.7520	0.3601
BX-161	19.5080	17.8400	0.8211	R-RX44	7.9980	7.2520	0.3601
BX-162	18.7360	17.5180	0.5961	R-RX45	8.6860	7.9400	0.3601
BX-163	22.0890	20.2690	0.8971	R-RX46	8.7480	7.8780	0.4221
BX-164	22.6560	20.2680	1.1811	R-RX47	9.6850	8.3150	0.6721
BX-165	24.8080	22.8580	0.9621	R-RX49	10.9980	10.2520	0.3601
BX-166	25.4110	22.8570	1.2641	R-RX50	11.1850	10.0650	0.5471
BX-167	30.1530	28.5410	0.7931	R-RX53	13.1230	12.3770	0.3601
BX-168	30.3850	28.5410	0.9091	R-RX54	13.3100	12.1900	0.5471
BX-169	6.8590	5.7190	0.5571	R-RX57	15.3730	14.6270	0.3601
BX-170	8.6000	7.3820	0.5961	R-RX63	17.4670	15.5330	0.9541
BX-171	10.5450	9.3270	0.5961	R-RX65	18.8730	18.1270	0.3601
BX-172	13.1290	11.9110	0.5961	R-RX66	19.0600	17.9400	0.5471
BX-303	33.8530	31.8890	0.9691	R-RX69	21.3730	20.6270	0.3601
				R-RX70	21.6850	20.3150	0.6721
				R-RX73	23.4350	22.5650	0.4221
				R-RX74	23.6850	22.3150	0.6721
				R-RX82	2.6230	1.8770	0.3601
				R-RX84	2.8730	2.1270	0.3601
				R-RX85	3.5600	2.6900	0.4221
				R-RX86	4.1230	3.0030	0.5471
				R-RX87	4.4980	3.3780	0.5471
				R-RX88	5.5600	4.1900	0.6721
				R-RX89	5.1850	3.8150	0.6721
				R-RX90	6.9350	5.3150	0.7971
				R-RX91	11.4670	9.0330	1.2041



## Origin of MIC TRAC Setting Dimensions

### MIC TRAC TF-BX Setting Blocks

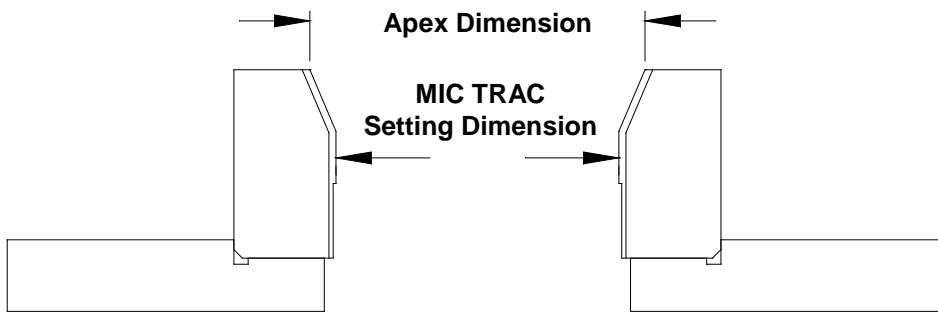
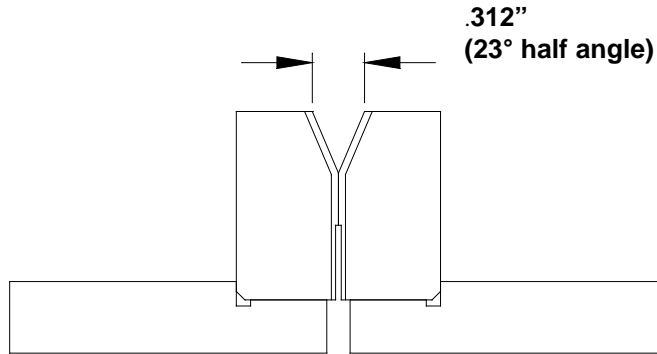

#### 6BX Flange Grooves

Width Setting = API "N"-.312  
Diameter Setting = API "G"-.312

#### 6B Flange Grooves

Width Setting = API "F"-.312  
Diameter Setting = (API "P"-.312) + API "F"

### MIC TRAC Setting Dimensions

Use with Gagemaker TF-BX Setting Blocks

6BX Flange Groove Settings			6B Flange Groove Settings		
Ring Number	Diameter Settings	Groove Width Settings	Ring Number	Diameter Settings	Groove Width Settings
BX-150	2.5810	0.1380	R-RX20	2.7200	0.0320
BX-151	2.7500	0.1540	R-RX23	3.4070	0.1570
BX-152	3.0830	0.1860	R-RX24	3.9070	0.1570
BX-153	3.7340	0.2420	R-RX25	4.0320	0.0320
BX-154	4.3730	0.2940	R-RX26	4.1570	0.1570
BX-155	5.6180	0.3860	R-RX27	4.4070	0.1570
BX-156	9.2090	0.6090	R-RX31	5.0320	0.1570
BX-157	11.4620	0.7270	R-RX35	5.5320	0.1570
BX-158	13.7520	0.8370	R-RX37	6.0320	0.1570
BX-159	16.7210	0.9670	R-RX39	6.5320	0.1570
BX-160	15.7510	0.4740	R-RX41	7.2820	0.1570
BX-161	19.2920	0.6180	R-RX44	7.7820	0.1570
BX-162	18.5200	0.3930	R-RX45	8.4700	0.1570
BX-163	21.8730	0.6940	R-RX46	8.5320	0.2190
BX-164	22.4400	0.9780	R-RX47	9.4690	0.4690
BX-165	24.5920	0.7590	R-RX49	10.7820	0.1570
BX-166	25.1950	1.0610	R-RX50	10.9690	0.3440
BX-167	29.9370	0.5900	R-RX53	12.9070	0.1570
BX-168	30.1690	0.7060	R-RX54	13.0940	0.3440
BX-169	6.6430	0.3540	R-RX57	15.1570	0.1570
BX-170	8.3840	0.3930	R-RX63	17.2510	0.7510
BX-171	10.3290	0.3930	R-RX65	18.6570	0.1570
BX-172	12.9130	0.3930	R-RX66	18.8440	0.3440
BX-303	33.6370	0.7660	R-RX69	21.1570	0.1570
			R-RX70	21.4690	0.4690
			R-RX73	23.2190	0.2190
			R-RX74	23.4690	0.4690
			R-RX82	2.4070	0.1570
			R-RX84	2.6570	0.1570
			R-RX85	3.3440	0.2190
			R-RX86	3.9070	0.3440
			R-RX87	4.2820	0.3440
			R-RX88	5.3440	0.4690
			R-RX89	4.9690	0.4690
			R-RX90	6.7190	0.5940
			R-RX91	11.2510	1.0010
			R-RX99	9.4070	0.1570

## *Care and Maintenance*

### **Maintenance Tips**

- Keep all unprotected metal surfaces coated with light oil.
- Avoid dropping the gage or subjecting it to any vibration or impact.
- Keep the gage dry and away from any machine coolant spray.
- Do not force the movement of any of the mechanical parts. The mechanics are designed to move freely.
- Keep the indicator face clean.

### **Warranty Information**

Gagemaker warrants its products to be free from defects in material and workmanship under normal operating conditions for 12 months from the date of shipment. This warranty is limited to repairing, or at Gagemaker's option, replacing any product which is proven to have been defective at the time it was shipped and/or suffered damage during shipping, provided buyer has given Gagemaker written notice of any such claimed defect within 15 days of receipt. Any defective product must be properly packed and shipped to the Gagemaker factory in Pasadena, Texas USA. This warranty applies to all products when used in a normal industrial environment. Any unauthorized tampering, misuse or neglect will make this warranty null and void. Under no circumstances will GAGEMAKER or any affiliate have any liabilities for loss or for any indirect or consequential damages. The foregoing warranties are in lieu of all other warranties expressed or implied, including but not limited to, the implied warranties of merchantability and fitness for a particular purpose.

### **Return products for repair or calibration to:**

**Gagemaker LP  
712 East Southmore Ave.  
Pasadena, TX 77502-110**

# **GAGEMAKER**

Gagemaker, LP, P.O. Box 87709, Houston, Texas 77287-7709  
712 East Southmore Ave., Pasadena, Texas 77502  
Phone: 713-472-7360  
Fax: 713-472-7241  
Web site: [www.gagemaker.com](http://www.gagemaker.com)